



E-Band, X6 Active Frequency Multiplier, 60 to 90 GHz, +16 dBm P_{out}

Description:

Model SFA-603903616-12SF-S1 is an active X6 frequency multiplier. The multiplier has an input frequency of 10 to 15 GHz with a typical input power of +3 dBm and an output frequency of 60 to 90 GHz with a typical output power of +16 dBm. The multiplier also has a typical harmonic suppression of -20 dBc. The DC power requirement for the multiplier is +8 V_{DC}/650 mA. The input port configuration is a female SMA connector and the output is a WR-12 waveguide with a UG-387/U anti-cocking flange. Other port configurations are available under different model numbers.



Features:

- Low Harmonic Emission
- Broad Band Coverage
- High Output Power

Applications:

- Frequency Extenders
- Source Modules
- Communication Systems

Electrical Specifications:

Parameter	Minimum	Typical	Maximum
Input Frequency	10 GHz		15 GHz
Input Power		+3 dBm	+20 dBm
Output Frequency	60 GHz		90 GHz
Output Power		+16 dBm	
Harmonic Suppression		-20 dBc	
Spurious		-60 dBc	
Port Return Loss		10 dB	
DC Voltage	+6 V _{DC}	+8 V _{DC}	+16 V _{DC}
DC Supply Current		650 mA	
Specification Temperature		+25 °C	
Operating Temperature	0 °C		+50 °C

Mechanical Specifications:

Item	Specification
Input Port	SMA(F)
Output Port	WR-12 Waveguide with UG-387/U Anti-Cocking Flange
Bias	Solder Pin
Case Material	Aluminum
Finish	Gold Plated
Weight	1.4 Oz
Size	1.10" (W) x 1.80" (L) x 0.50" (H)
Outline	FA-SE-1-A-1.8





E-Band, X6 Active Frequency Multiplier, 60 to 90 GHz, +16 dBm P_{out}

Typical Output Power vs. Frequency

Bias: +8 V_{DC}/650 mA, Input Power: +3 dBm

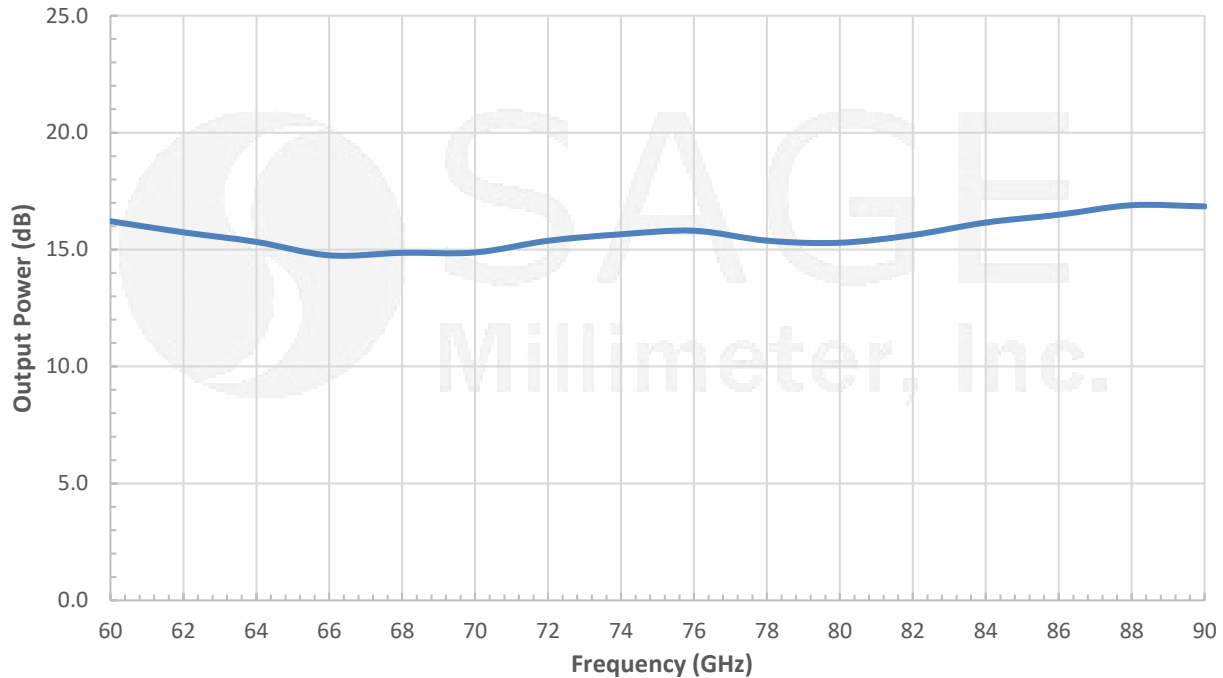

Mechanical Outline: (Unless otherwise specified, all dimensions are in inches [millimeters])

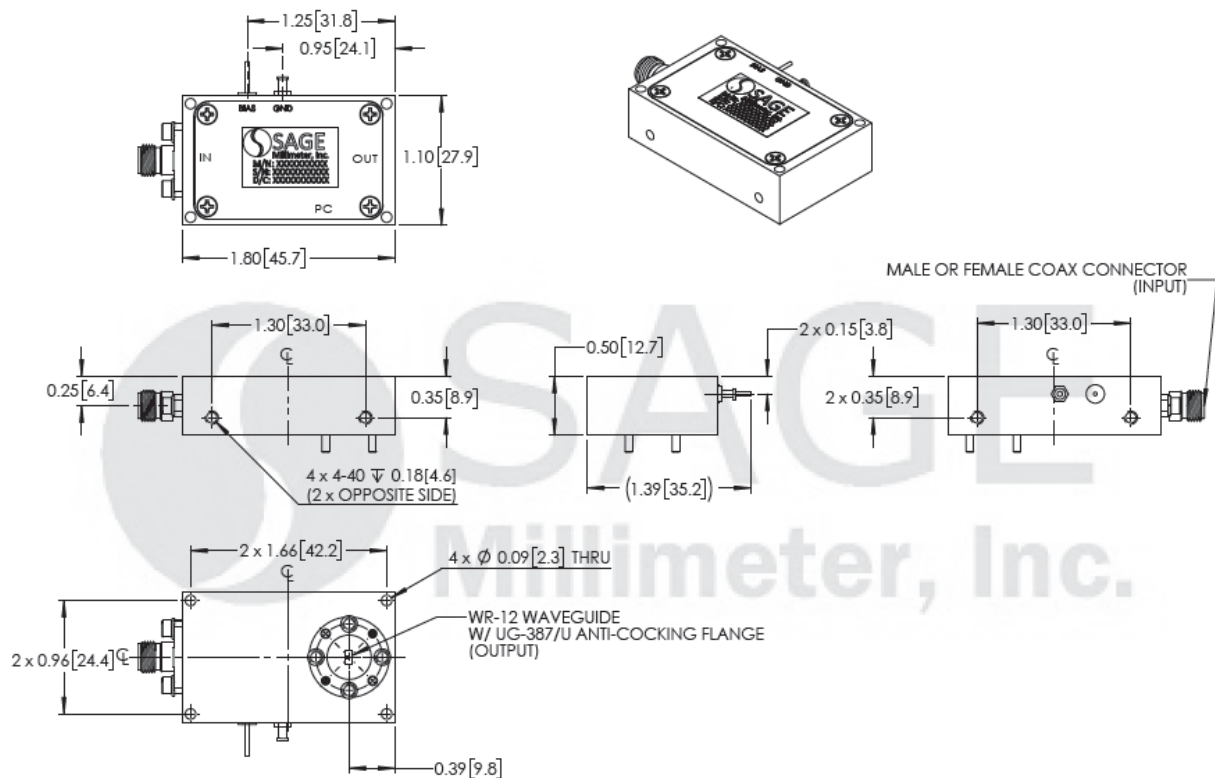



E-Band, X6 Active Frequency Multiplier, 60 to 90 GHz, +16 dBm P_{out}

Note:

- All data presented is collected from a sample lot. Actual data may vary unit to unit, slightly.
- All testing was performed under +25 °C case temperature.
- SAGE Millimeter, Inc. reserves the right to change the information presented without notice.
- Other mechanical configurations are available under different model numbers.

Caution:

- Exceeding absolute maximum ratings shown will damage the device.
- The device is static sensitive. Always follow ESD rules when working with the device.
- The case temperature of the device shall never exceed +50 °C. Use proper heatsink or fan if necessary.
- Any foreign objects in the waveguide will cause performance degradation and may damage the device.
- Proper torque, 8.0 ± 0.15 inch-pounds (0.90 ± 0.02 Nm), should be applied. **SAGE Millimeter torque wrench, model SCH-08008-S1, is highly recommended.**

