



35.00 GHz Doppler Sensor Head, Single Channel, Long Range

Description:

Model SSS-35310-22L-S1 is Ka Band, lens antenna-based Doppler sensor head that is designed and manufactured for **long range** measurements of a moving target's speed. The sensor head has a center frequency of 35 GHz and takes a nominal bias of +5.0 VDC/250 mA. The sensor heads are configured with a lens corrected antenna, T/R diplexer, a single channel receiver and a transmitter/receiver oscillator in an integrated package. Sensor heads with a dual receiver are offered under model number **SSS-35310-22L-D1** and can detect both the speed and direction of a moving target.



Features:

- 35.00 GHz Operation
- Low Flicker Noise and High Sensitivity
- Low Harmonic Emission

Applications:

- Traffic Management Systems
- Microwave Fence
- Military Surveillance Systems

Electrical Specifications:

Parameter	Minimum	Typical	Maximum
Antenna 3 dB Beamwidth		12°	
Antenna Side Lobes		-20 dB	
Antenna Gain		22 dBi	
Antenna Polarization		Right-Handed Circular	
RF Frequency Range	33.9 GHz	35.0 GHz	36.1 GHz
Transmitting Power		+10 dBm	
IF Frequency Range	DC		100 MHz
IF Offset Voltage		±0.1 V _{DC}	
Frequency Stability		-0.3 MHz/°C	
Power Stability		-0.03 dB/°C	
DC Supply Voltage		+5 V _{DC} /250 mA	+5.5 V _{DC}
Specification Temperature		+25°C	
Case Temperature	-40°C		+85°C





35.00 GHz Doppler Sensor Head, Single Channel, Long Range

Mechanical Specifications:

Item	Specification
Gunn Oscillator Bias Port	Red Wire
Mixer IF Port	Solder Pin
Mixer IF Ground	Solder Pin
Size	2.38" (Ø) X 2.64" (L)
Material	Aluminum
Finish	Chem Film
Weight	5.0 Oz
Outline	SS-LA

Mechanical Outline: (Unless otherwise specified, all dimensions are in inches)

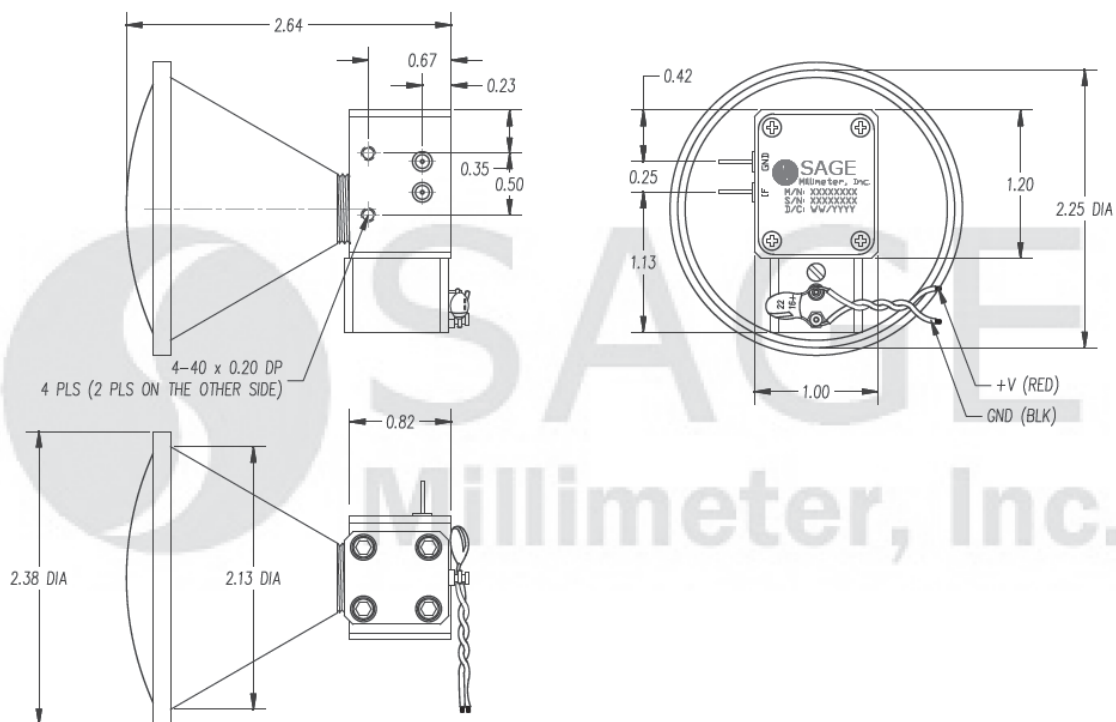

Note:

- SAGE Millimeter, Inc. reserves the right to change the information presented without notice.

Caution:

- The device is static sensitive. Always follow ESD rules when working with the device.
- Wrong bias or reverse bias on the sensor will damage the device.
- Exceeding absolute maximum ratings shown will damage the device. Use an additional heatsink or fan if necessary.

