



F-Band Waveguide Directional Coupler, 6 dB

Description:

Model SWD-0630H-08-SB is an F band, three-port waveguide directional coupler that delivers a 6 dB nominal coupling level and 25 dB minimum directivity across the full waveguide band from 90 to 140 GHz. The three-port coupler uses a traditional multi-hole and split block design to achieve a flat coupling level, high directivity, and low insertion loss. The interfaces of the coupler are WR-08 waveguides with UG-387/U-M flanges. Custom coupling levels are available under different model numbers.



Features:

- Full Band Operation
- Low Insertion Loss
- High Directivity

Applications:

- Test Labs
- Instrumentation
- Sub-assemblies

Electrical Specifications:

Parameter	Minimum	Typical	Maximum
Frequency	90 GHz		140 GHz
Insertion Loss*		2.5 dB	
Coupling*		6 dB	
Directivity*	25 dB		
VSWR		1.2:1	
Specification Temperature		+25°C	
Operating Temperature	-40°C		+85°C

*The definition of insertion loss, coupling and directivity is show below:

Insertion Loss = $-10 \log_{10} [(P2+P3)/P1]$ Coupling Value = $-10 \log_{10} [P3/P1]$	
Directivity = $-10 \log_{10} [P3/P2]$	





F-Band Waveguide Directional Coupler, 6 dB

Mechanical Specifications:

Item	Specification
Through Ports	WR-08 Waveguide with UG-387/U-M Flange
Coupled Port	WR-08 Waveguide with UG-387/U-M Flange
Size	3.60" (L) X 0.95" (W) x 0.83" (H)
Material	Brass
Finish	Gold Plated
Weight	7.7 Oz
Outline	WD-SB-F

Mechanical Outline: (Unless otherwise specified, all dimensions are in inches)

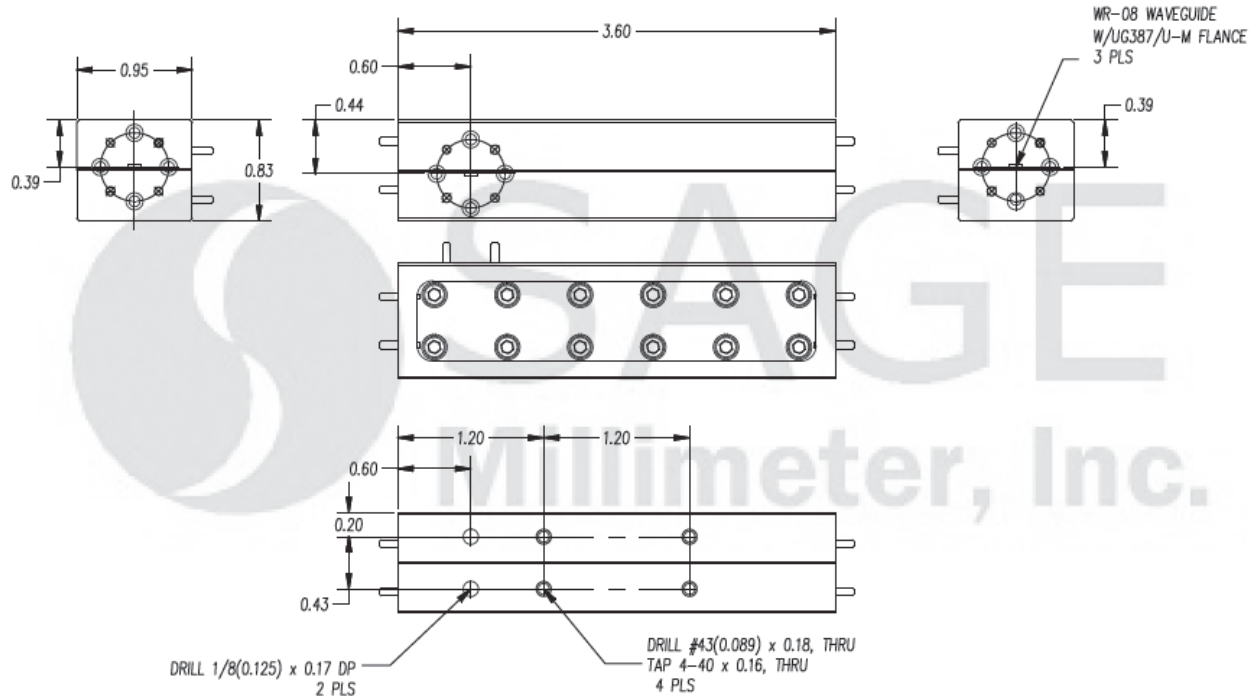

Note:

- SAGE Millimeter, Inc. reserves the right to change the information presented without notice.

Caution:

- Any foreign objects in the waveguide will degrade performance and/or damage the device.

