



U-Band Waveguide Bi-Directional Coupler, 6 dB

Description:

Model SWD-0640H-19-BB is a U band, four-port waveguide bi-directional coupler that delivers a 6 dB nominal coupling level and 35 dB minimum directivity across the full waveguide band from 40 to 60 GHz. The four-port coupler uses a traditional multi-hole and split block design to achieve a flat coupling level, high directivity, and low insertion loss. The interfaces of the coupler are WR-19 waveguides with UG-383/U-M flanges. Custom coupling levels are available under different model numbers.



Features:

- Full Band Operation
- Low Insertion Loss
- High Directivity

Applications:

- Test Labs
- Instrumentation
- Sub-assemblies

Electrical Specifications:

Parameter	Minimum	Typical	Maximum
Frequency	40 GHz		60 GHz
Insertion Loss*		0.7 dB	
Coupling*		6 dB	
Directivity*	35 dB		
VSWR			1.1:1
Specification Temperature		+25°C	
Operating Temperature	-40°C		+85°C

* The definition of the insertion loss, coupling and directivity is show as following.

Insertion Loss = $-10 \log_{10} [(P2+P3)/P1]$ when P4 is terminated. Coupling Value = $-10 \log_{10} [P3/P1]$ when P4 is terminated. or $-10 \log_{10} [P4/P2]$ when P3 is terminated.	
Directivity = $-10 \log_{10} [P3/P2]$ when P4 is terminated. Directivity = $-10 \log_{10} [P4/P1]$ when P3 is terminated.	





U-Band Waveguide Bi-Directional Coupler, 6 dB

Mechanical Specifications:

Item	Specification
Through Ports	WR-19 Waveguide with UG-383/U-M Flange
Coupled Port	WR-19 Waveguide with UG-383/U-M Flange
Size	5.50" (L) x 1.30" (W) x 1.25" (H)
Material	Brass
Finish	Gold Plated
Weight	1.58 Lb
Outline	WD-BB-U

Mechanical Outline: (Unless otherwise specified, all dimensions are in inches)

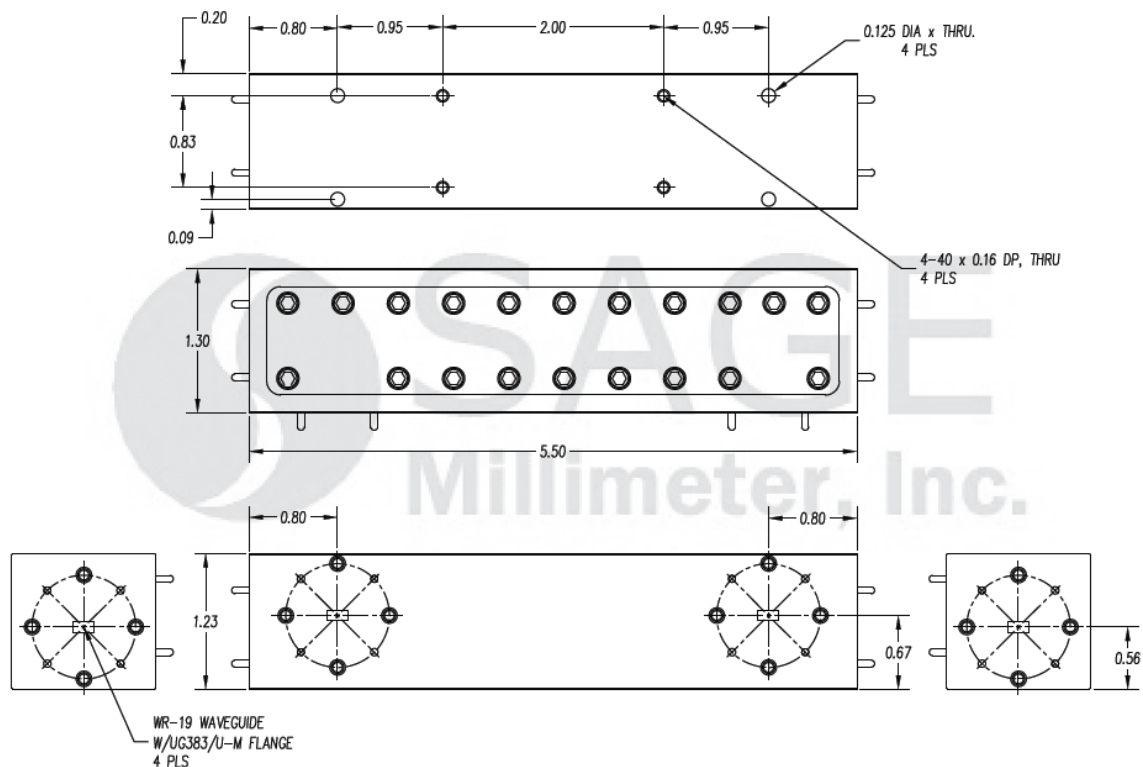

Note:

- All data was presented using a limited sample lot. Actual data may vary unit to unit.
- The insertion loss shown includes the loss due to coupling.
- SAGE Millimeter, Inc. reserves the right to change the information presented without notice.

Caution:

- Any foreign objects in the waveguide will degrade performance and/or damage the device.

